

# Smart Control of Temperature and Audio Monitoring Inside Beehive: IoT ESP8266 NodeMCU and Android Mobile Platforms

Andrey Kupin<sup>b</sup>, Dmytro Zubov<sup>a</sup>, Aiza Zhenishbekova<sup>a</sup>

<sup>a</sup> University of Central Asia, 125/1 Toktogul Street, Bishkek, 720001, Kyrgyzstan

<sup>b</sup> Kryvyi Rih National University, 11 Vitaly Matusevich, Kryvyi Rih, 50027, Ukraine

## Abstract

In this study, a prototype of a smart control system for temperature management in cold weather and audio monitoring inside a beehive was developed at an affordable price of USD 14 using IoT ESP8266 NodeMCU, temperature sensor DS18B20, sound sensor KS0035, and two 8 W portable waterproof heaters. The IoT device does not require any special installation and works in autonomous and network modes displaying information on the beekeeper's Android smartphone. A Java Android application was developed using Google's WebView system component. The beekeeper is notified if a bee fanning noise, such as honeybee queenlessness, is detected. This occurs when at least four measurements exceed a digital value of 200 in a sequence of 100 elements. This rule was observed in the experiment at the apiary in the At-Bashi region of Kyrgyzstan. The automatic management of the temperature inside a beehive was implemented by employing a two-position control algorithm. The results of the experiment conducted at the campus of the University of Central Asia (city of Naryn, Kyrgyzstan) showed the operability of the developed prototype at negative outdoor temperatures.

## Keywords

Beehive, ESP8266 NodeMCU, DS18B20, temperature control, audio monitoring

## 1. Introduction

Honeybees are crucial pollinators for natural ecosystems and contributors to sustainable development targets such as the quantity and quality of food, nutrition, medicine, inclusive communities, forest conservation and regrowth, healthy and diverse ecosystems, innovation and inspiration, biofuels, and economic opportunities [1, 2]. Some apiaries experience high mortality due to factors such as natural disasters and internal beehive issues. These can include floods, fires, droughts, extremely cold temperatures, honeybee starvation, and honeybee queenlessness. For instance, approximately 38 % of beekeepers' colonies in the United States died between October 1, 2018, and April 1, 2019 [3]. However, very few control systems (e.g., [4-8]) have been developed to notify beekeepers and minimize the impact of negative external and internal factors on the beehive. Approximately 35 % of bee colonies support 75 % of crops worldwide [7], and hence even a small success rate in the survival of honeybees implies a large global benefit.

Existing devices, such as those referenced in [4-6, 8-10], employ various sensors (e.g., temperature, humidity, sound, piezoelectric transducer, motion, and flame) to monitor parameters inside and outside a beehive. Inside the beehive, climate control (temperature mainly, but humidity as well) and audio monitoring (mostly amplitude and frequency) are emphasized. However, some commercial products are quite expensive. For instance, the Beewise Beehome costs USD 400 per month for 24 bee colonies as of May 2023 [8]. In addition, some devices are relatively large (e.g., a Bee Board module is approx. 30×20×5 cm [10]) and require special external installation.

---

ICST-2023: Information Control Systems & Technologies, September 21-23, 2023, Odesa, Ukraine.

EMAIL: kupin@knu.edu.ua (A. Kupin); dzubov@ieee.org (D. Zubov); aiza.zhenishbekova\_2023@ucentralasia.org (A. Zhenishbekova)

ORCID: 0000-0001-7569-1721 (A. Kupin); 0000-0002-5601-7827 (D. Zubov); 0009-0006-2683-3360 (A. Zhenishbekova)



© 2023 Copyright for this paper by its authors.

Use permitted under Creative Commons License Attribution 4.0 International (CC BY 4.0).

CEUR Workshop Proceedings (CEUR-WS.org)

This study presents a prototype of an Internet of Things (IoT) device for temperature control and audio monitoring inside a beehive. The main hardware components are the ESP8266 NodeMCU (Node MicroController Unit) board [11] (approx. USD 2), temperature sensor DS18B20 (approx. USD 1), BESTEP 3.3 V trigger relay (approx. USD 2), Keyestudio microphone sound sensor KS0035 (approx. USD 3), two 8 W portable waterproof heaters (approx. USD 4 for two pieces), enclosure (approx. USD 1), breadboard and wires (approx. USD 1). The size of the box is approx. 85×85×44 mm, and it does not require any special installation. The external power supply, for example, solar panels with batteries or power grid lines, depends on the apiary location; hence, its price is not initially considered. A WiFi router is an optional device that connects ESP8266 NodeMCU boards and the beekeeper's Android smartphone. Thus, the basic price of the kit is approx. USD 14, which is an affordable competitive level.

This study addresses two problems in the development of an IoT device for temperature control and audio monitoring inside a beehive.

1. A new portable soft-/hardware complex of the affordable price of USD 14 was developed employing automatic configuration (autonomous / network) at the system start.
2. A web-based mobile user interface [12] was designed to support the beekeeper's decision-making using information about the state of heaters (ON/OFF), the temperature, the maximum audio signal in a first-in, first-out (FIFO) queue of 100 elements inside specific beehive (the mobile app activity shows a list of beehives at the beginning), and a bee fanning noise if it is detected.

The paper is organized as follows: Section 2 presents the related work; Section 3 discusses the system soft-/hardware design; Section 4 describes the data acquisition and two-position automatic control of the temperature inside a beehive; and Section 5 summarizes the achieved outcomes.

## 2. Related work

In this study, two categories of related work are analyzed: remote data acquisition and automatic control of parameters inside a beehive.

Focusing on data acquisition from beehives, some contributions can be found in [4-10, 13-15]. Different sensors (e.g., temperature, humidity, weight, air quality, camera, microphone) are employed to monitor parameters inside and outside a beehive via cable and/or wireless connection.

In [10, 14], the acquisition of the hive weight (Sparkfun load sensor with HX711 load cell amplifier), sounds emitted by the bees (Analog Devices ADMP401), temperature and humidity (DHT22 sensor), and CO<sub>2</sub> (Telaire TL6615 sensor) inside a beehive, and weather conditions (ambient temperature, humidity, atmospheric pressure, UV-light, visible light, infrared light, rain, wind intensity and direction) is externally implemented using the Raspberry Pi 3 B microcomputer with cable connection to the Ethernet switch that communicates wirelessly to a remote server. The price was not pointed out in [10, 14], but the current market shows that it is above USD 100 because of the Raspberry Pi 3 B board and sensors. The size of the Bee Board module is approx. 30×20×5 cm. In addition, it requires special external installation.

References [9, 13] discuss audio monitoring inside and outside a beehive:

1. Detect bees, swarming, queen bee absence, mite attack, environmental effects, arrival, and departure of bees.
2. Predict hive strength.
3. Identify bee species.
4. Pollination efficacy measurement.

Complicated AI (Artificial Intelligence) algorithms, such as LR, KNN, RF, HMM, PCA, CNN, SVM, and LDA, are employed for audio-based beehive monitoring [9]. This approach requires high-quality and omnidirectional microphones, such as Analog Devices ADMP401, and high-performance microcomputers, such as Raspberry Pi 3 B / 4 B, which makes the device expensive and relatively large.

In [15], an infrared camera tracked social interactions among honeybees in a flat laboratory arena. This approach requires high-performance computing for image recognition, and the infrared camera needs additional power to supply infrared lighting if it is necessary to increase camera visibility in the dark.

Focusing on the automatic control of parameters inside a beehive, some contributions can be found in [4-8]. Different actuators, such as heaters and ventilators, are employed to control parameters inside the beehive (mostly temperature and humidity).

In [6], the implementation of a heating system with central and lateral heaters showed that the feed consumption was reduced by 1.8 kg compared to a beehive without heating during the five cold months. In winter, hives with electric heating had 10-30 dead bees per family while hives without heating had 100-200 dead bees per family. It was pointed out that the surface temperature of the heater should not exceed 47°C (not to injure bees). During the five cold months, the electricity consumption was 9 kWh which was quite high.

In [5], a 36 W intra-frame heater was installed inside a beehive employing a microcontroller PIC18F452 and temperature/humidity sensor SHT11. The heater is composed of nine-row wire resistance, and the warm air spreads through holes smaller than 2.5 mm (bees should not touch the resistance). This device required special installation.

In [7, 8], a Beewise Beehome robotized system was employed to manage 24 beehives and automate pollination, honey production and reproduction. Solar panels provide 100 % power for automated robotic brood box management, a computer vision-based monitoring system, AI decision-making, automated honey harvesting, automated pest control, feeding, and thermoregulation. The price was USD 400 per month as of May 2023.

In [4], a self-powered smart beehive monitoring and control system (SBMaCS) used different sensors to measure parameters inside and outside a beehive, such as temperature and humidity sensor, piezoelectric transducer, and flame sensor, to secure bee colonies and increase honey productivity. The device employs energy harvesting for self-power supply using radio frequency energy and vibrations from adult bees through a piezoelectric transducer. A mobile phone application was developed for supervisory control and data acquisition. However, the Arduino Uno microcontroller with a separate Digi XBee S1 wireless module and sensors complicates the system and makes it larger than the available space inside the beehive. The total price is assumed to be around USD 100 since only Arduino Uno and Digi XBee S1 boards cost over USD 40.

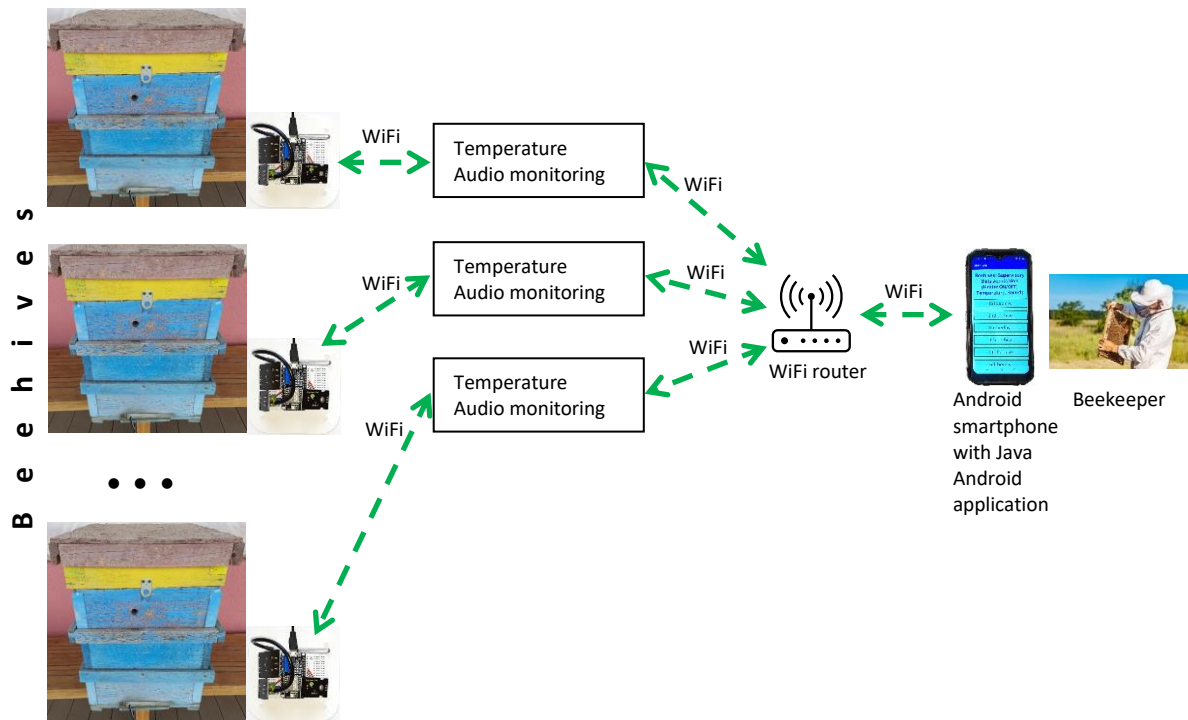
A review of the above-mentioned studies [4-10, 13-15] on remote data acquisition and automatic control of parameters inside a beehive shows that commercial products should be affordable and meet the following criteria:

1. Remotely monitor essential parameters such as temperature and sound, for example, via a mobile application.
2. Control the temperature in cold weather inside a beehive remotely and/or automatically even without a cable or WiFi connection.
3. Provide beekeepers with information about necessary actions such as checking the beehive if a bee fanning noise is detected.
4. The device should not require any special installation.

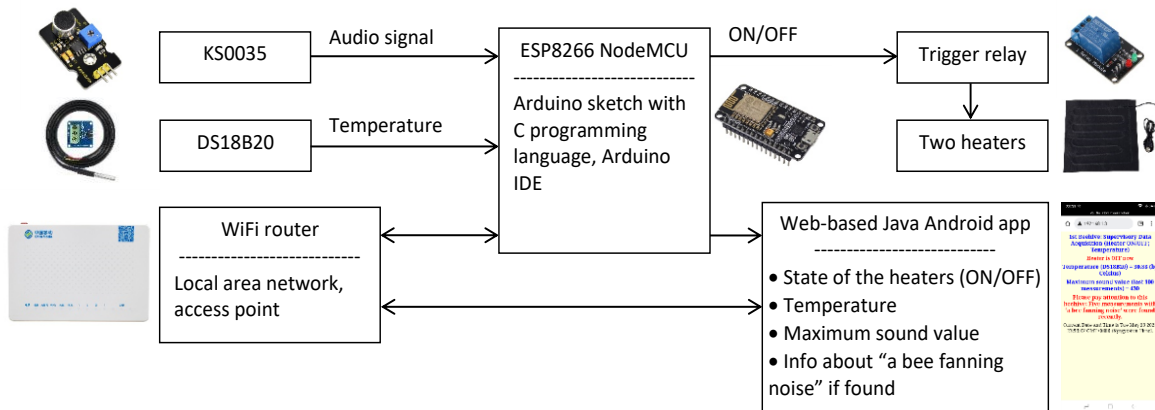
In this study, the ESP8266 NodeMCU microcomputer monitors the temperature and sound inside a beehive via sensors DS18B20 and KS0035 and controls the internal temperature based on the BESTEP 3.3 V trigger relay and two 8 W portable waterproof heaters. A diagram of the proposed approach is shown in Figure 1. The power supply method is not discussed in this project because of the existing standard solutions such as low-voltage distribution power lines and solar panels with solar controllers/batteries that are selected according to the customer's preferences when the product is sold.

### **3. System soft-/hardware design**

The soft-/hardware complex is composed of two parts – Java Android application (smartphone Doogee S96 Pro with Android 10 operating system (OS) and IP68 dust/water resistance is employed in this prototype) and ESP8266 node microcontroller unit with temperature sensor DS18B20, BESTEP 3.3 V trigger relay (Keyestudio 5 V relay KS0011 also showed the operability in experiments), Keyestudio microphone sound sensor KS0035, and two 8 W portable waterproof heaters. The smartphone and microcontroller are connected via a WiFi router (ZTE ZXHN F663N in this prototype; see Figure 2).



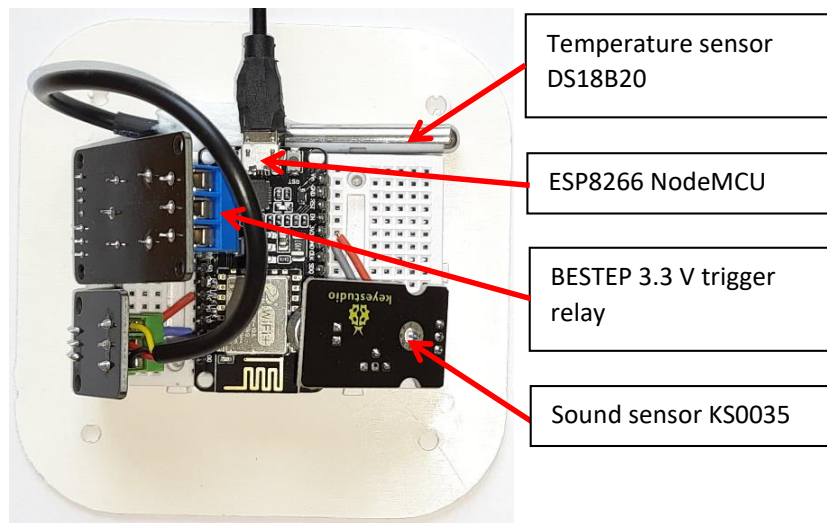
**Figure 1:** A diagram of the proposed approach



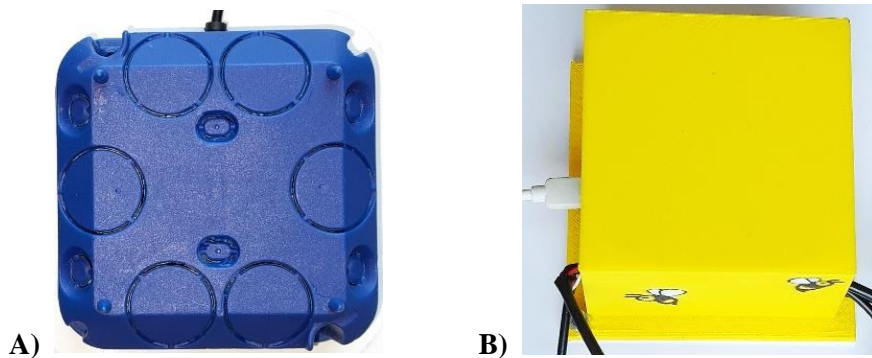
**Figure 2:** System soft-/hardware structure

The ESP8266 NodeMCU board runs an Arduino sketch developed in the Arduino IDE (Integrated Development Environment) using C programming language. It hosts an HTML (Hypertext Markup Language) website on a web server and is wired to the temperature sensor DS18B20 (in-box solution is presented without heaters in Figure 3), BESTEP 3.3 V trigger relay, and Keyestudio microphone sound sensor KS0035 on a breadboard. The relay is connected to the digital pin D5 (internal designation is GPIO14 – general purpose input/output pin 14), the Keyestudio microphone sound sensor KS0035 to the analog pin A0 (internal designation is ADC0), the temperature sensor DS18B20 to digital pin D2 (internal designation is GPIO4) of ESP8266 NodeMCU. Jumper wires are made of non-corrosive and low-resistance copper. All hardware components operate in temperatures from  $-40^{\circ}\text{C}$  to  $+100^{\circ}\text{C}$ .

During the prototyping, two types of enclosures were used: a plastic junction box with the internal installation of temperature sensor DS18B20 and a 3D printed box (DS18B20 is outside; see Figure 4). The waterproof sensor DS18B20 is suitable for both internal and external installations, which is its advantage compared to the DHT22 sensor.

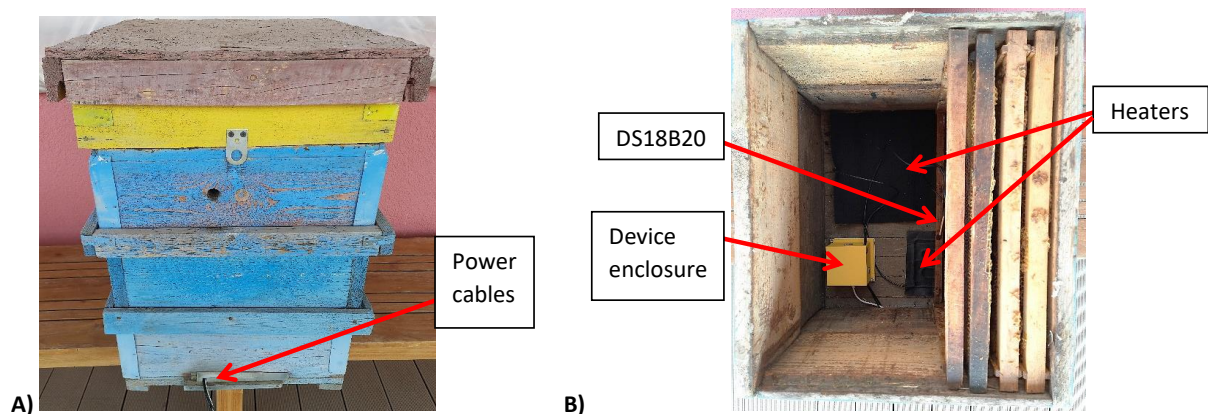


**Figure 3:** ESP8266 NodeMCU board with temperature sensor DS18B20, BESTEP 3.3 V trigger relay, and Keyestudio microphone sound sensor KS0035



**Figure 4:** Two types of enclosures – plastic junction box (A) and 3D printed box (B)

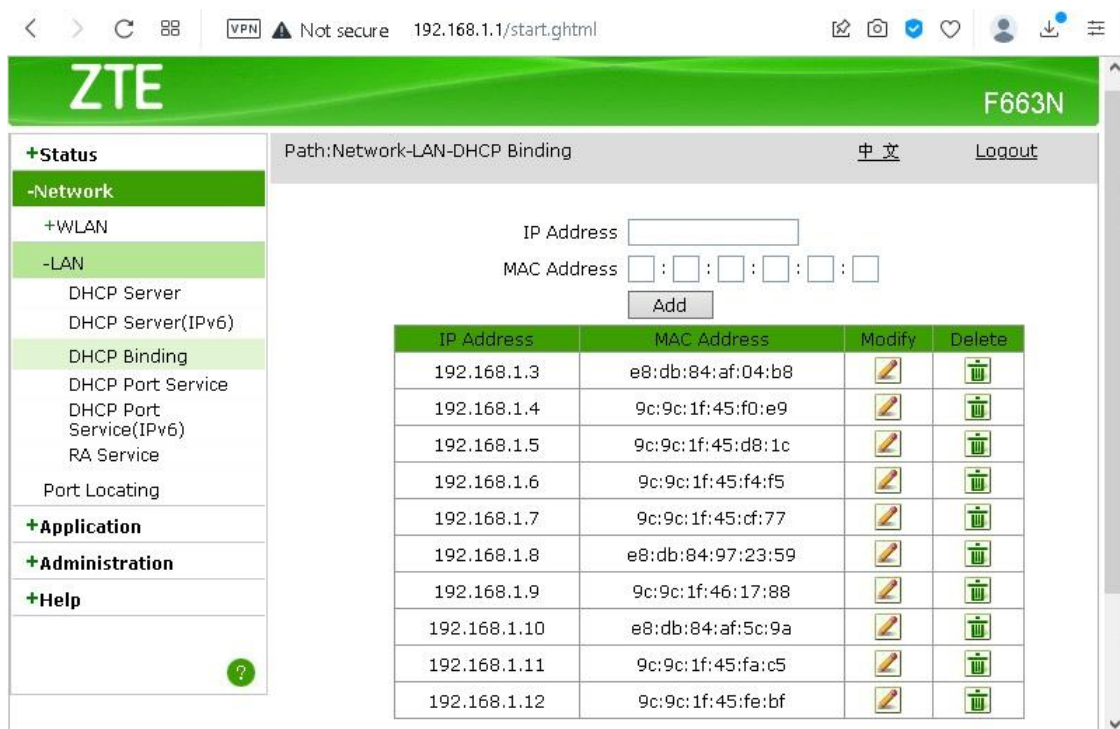
The prototype was installed on the bottom board as presented in Figure 5: the left photo shows the beehive externally and the right photo depicts the prototype enclosure inside a beehive with two 8 W portable waterproof heaters and the temperature sensor DS18B20 attached to the honeycomb.



**Figure 5:** External photo of the beehive (A) and the prototype enclosure inside a beehive with two portable waterproof heaters and the temperature sensor DS18B20 attached to the honeycomb (B)

The research question is what power of heaters is needed to keep the temperature around 0 °C inside a beehive. It is assumed that the beehive is winterized (i.e., heat insulation is added internally and/or externally) and has dimensions 0.6×0.5×0.4 m (i.e., the volume is 0.12 m<sup>3</sup>). In general, 1000 W is suitable to heat the space of 25 m<sup>3</sup>, and hence 16 W, the power provided by two heaters, should be enough for 0.4 m<sup>3</sup> that is over three times larger than the discussed volume of the beehive (0.12 m<sup>3</sup>). This result corresponds to the results presented in [6].

The WiFi router ZTE ZXHN F663N connects all devices to the local area network. Ten beehives are considered in the prototype (the number can be extended), and hence ten static IPv4 (Internet Protocol version 4) addresses were bound to ten MAC (Media Access Control) addresses of ESP8266 NodeMCUs, as shown in Figure 6. The beekeeper acquires information by typing the IPv4 address of specific beehive in the web browser on the network end device, such as smartphone, laptop, and desktop computer, connected to the access point (see screenshot in Figure 2) or simply selecting a beehive on the mobile application start activity.



**Figure 6:** Ten static IPv4 addresses are bound to ten MAC addresses of ESP8266 NodeMCUs in the WiFi router ZTE ZXHN F663N

A web-based Java Android mobile application was developed in Android Studio 4.0 (see Figure 7) for Android 10 OS and newer. Its main functionality is based on the Android WebView system component from Google, which allows Android applications to display web content. On the start stage, the Java Android mobile application shows the HTML file “index.html” stored in a folder “assets”, which is the list of beehives (see Figure 8). The beekeeper selects specific beehive by clicking it on the screen, and then the following information is displayed: the state of heaters (ON/OFF), the temperature, the maximum audio signal in a FIFO queue of 100 elements inside specific beehive, and a bee fanning noise if it is detected (see Figure 8). Abnormal values of audio signals show the extraordinary situations happening in a beehive [13].

#### 4. Data acquisition and two-position automatic control of the temperature inside a beehive

The temperature inside a beehive is the first parameter shown to the beekeeper in this prototype. It

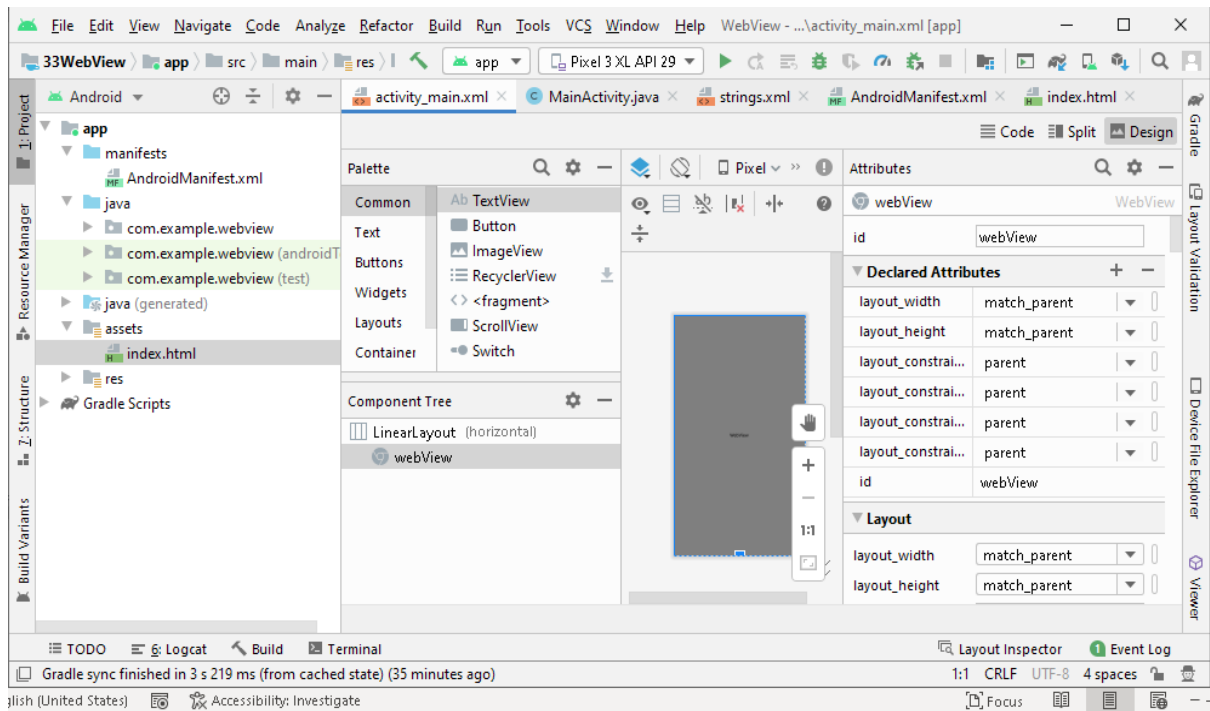


Figure 7: Web-based Java Android mobile application in Android Studio 4.0

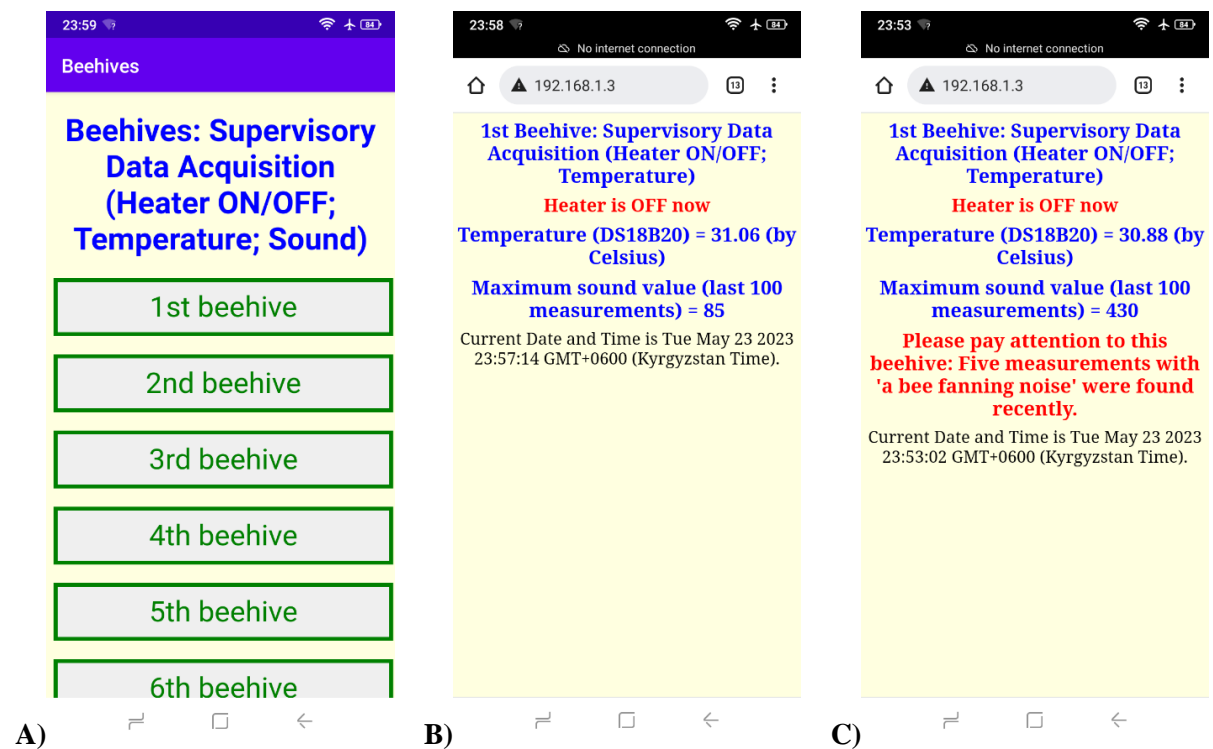
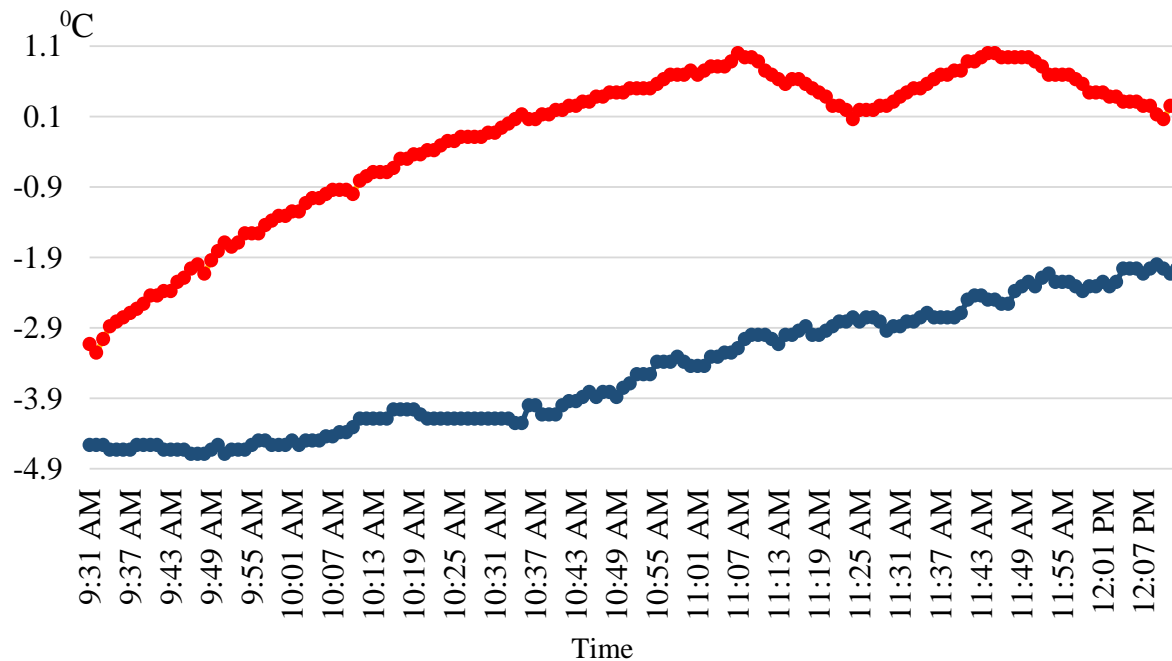


Figure 8: Screenshots of web-based Java Android mobile application – list of beehives (A) and two examples of the information acquired from the 1st beehive (B and C)

is automatically controlled by a well-known two-position control algorithm that abruptly switches between two states. The trigger relay turns heaters on if the temperature inside a beehive is less than  $0^{\circ}\text{C}$ , and off if the temperature is larger than  $1^{\circ}\text{C}$ . The prototype was tested outdoors on the campus of the University of Central Asia (city of Naryn, Kyrgyzstan) on March 7, 2023. The results are shown in Figure 9, where the temperature inside a beehive was changed between  $0^{\circ}\text{C}$  and  $1^{\circ}\text{C}$  (red line) after

the warm-up stage, whereas the outdoor temperature was from  $-4^{\circ}\text{C}$  to  $-2^{\circ}\text{C}$  (blue line). The target temperature range  $0^{\circ}\text{C} - +1^{\circ}\text{C}$  was suggested by beekeepers from the At-Bashi region of Kyrgyzstan.



**Figure 9:** Results of the outdoor experiment – two-position automatic control of the temperature inside a beehive

The information about the audio monitoring inside a beehive is a second parameter that is shown to the beekeeper in this prototype. Two types of audio information are as follows:

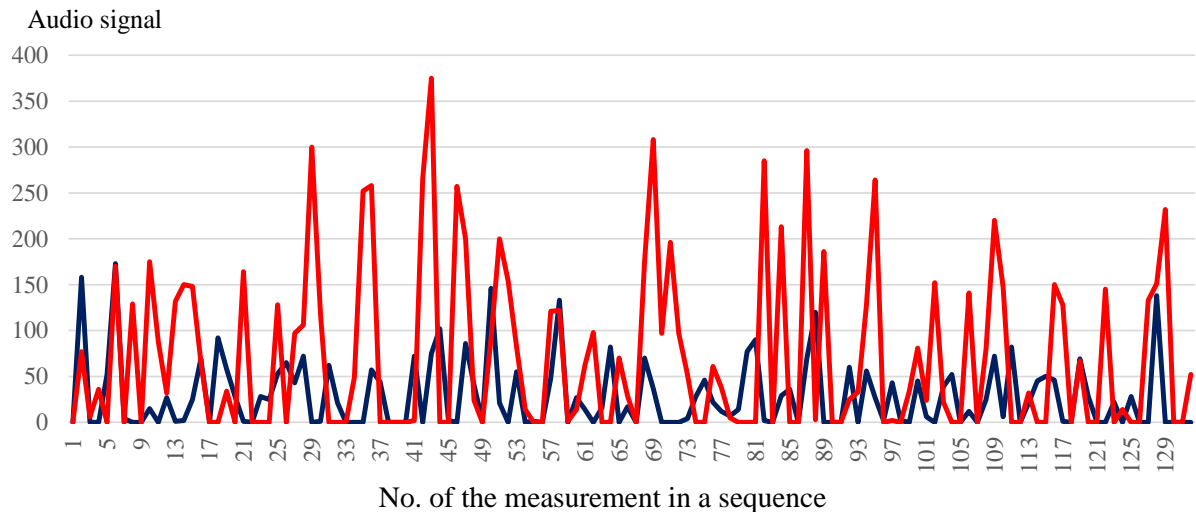
1. Maximum audio signal in a FIFO queue of 100 elements.
2. A bee fanning noise if it is detected.

In the first case, the maximum value is obtained in the sequence of 100 numbers. In the second case, the beekeeper is notified if a bee fanning noise, such as honeybee queenlessness, is detected. This occurs when at least four measurements exceed a digital value of 200 in a sequence of 100 elements. This rule was observed in an actual experiment performed at an apiary in the At-Bashi region of Kyrgyzstan. Aiza Zhenishbekova collected data using the portable handy recorder Zoom H6. Examples of audio samples are presented in Figure 10 (red line – without honeybee queen; blue line – with honeybee queen; the time interval between measurements is 0.5 s; available for download at <https://drive.google.com/drive/folders/14GNXIQzfjztMakAsI0tJE0hRtj5Qhp3W?usp=sharing>). The KS0035 sensor potentiometer was manually adjusted for the microphone's maximum sensitivity; hence, the device could be easily adapted to different types of bees and sound/noise levels. An example of the device installed in the beehive at an apiary in the At-Bashi region of Kyrgyzstan is shown in Figure 11. Experiments using audio samples showed 100 % accuracy for the proposed approach.

## 5. Conclusions

In this study, a new prototype was developed to support bee colonies via temperature control in cold weather and monitoring the audio inside a beehive. The affordable price of USD 14 is provided by the low-cost reliable IoT equipment: ESP8266 NodeMCU, temperature sensor DS18B20, BESTEP 3.3 V trigger relay, Keyestudio microphone sound sensor KS0035, and two 8 W portable waterproof heaters. Two-position automatic control of the temperature inside a beehive with the possibility to display it on the screen of the Android smartphone along with the information about the maximum audio signal in a FIFO queue of 100 elements and a bee fanning noise makes this prototype different and competitive. The developed device does not require special installation on the bottom of a beehive.





**Figure 10:** Examples of audio samples (red line – without honeybee queen, blue line – with honeybee queen)



**Figure 11:** An example of the device installed in the beehive at an apiary in the At-Bashi region of Kyrgyzstan

The beekeeper is notified of a bee fanning noise if at least four measurements are larger than a digital value of 200 in a sequence of 100 elements. This rule was observed in the experiment at the apiary in the At-Bashi region of Kyrgyzstan. Experiments using audio samples showed 100 % accuracy for the proposed approach.

Further development of this study may include the application of machine learning algorithms to automatically identify audio anomalies inside a beehive, such as a honeybee queenlessness.

## 6. Acronyms and abbreviations

Table 1 lists acronyms and abbreviations used in the paper.

**Table 1**

Acronyms and abbreviations

Acronyms and abbreviations	Description
AI	Artificial Intelligence
CNN	Convolutional Neural Network
FIFO	First-In, First-Out: A method of queuing
GPIO	General Purpose Input/Output
HMM	Hidden Markov Model
HTML	Hypertext Markup Language
IDE	Integrated Development Environment
IoT	Internet of Things
IPv4	Internet Protocol version 4
KNN	k-Nearest Neighbors
LDA	Linear Discriminant Analysis
LR	Logistic Regression
MAC	Media Access Control
NodeMCU	Node MicroController Unit
OS	Operating System
PCA	Principal Component Analysis
RF	Random Forest
SBMaCS	Self-Powered Smart Beehive Monitoring and Control System
SVM	Support Vector Machine
UV	Ultraviolet
USD	United States dollar(s)
WiFi	Wireless Fidelity: Wireless network protocols based on the IEEE 802.11 family of standards

## 7. Data availability

The data supporting the conclusions of this work are available from the corresponding author Dr. Dmytro Zubov upon request.

## 8. Conflicts of interest

The authors declare no conflicts of interest for publication.

## 9. Acknowledgments

The authors sincerely appreciate the management and colleagues at the University of Central Asia and Kryvyi Rih National University for their patience and kind assistance in completing the present study.

## 10. References

- [1] D. M. Katumo, H. Liang, A. C. Ochola, M. Lv, Q.-F. Wang, C.-F. Yang, Pollinator diversity benefits natural and agricultural ecosystems, environmental health, and human welfare, *J. Plant Diversity*, 44 5 (2022) 429-435. doi:10.1016/j.pld.2022.01.005.

- [2] V. Patel, N. Pauli, E. Biggs, L. Barbour, B. Boruff, Why bees are critical for achieving sustainable development, *J. Ambio*, 50 1 (2021) 49-59. doi:10.1007/s13280-020-01333-9.
- [3] S. Milius, U.S. honeybees had the worst winter die-off in more than a decade, *Science News*, 2019. URL: <https://www.sciencenews.org/article/us-honeybees-had-worst-winter-die-more-decade>.
- [4] E. Ntawuzumusi, S. Kumaran, L. Sibomana, Self-powered smart beehive monitoring and control system (SBMaCS), *J. Sensors*, 21 (2021) 3522. doi:10.3390/s21103522.
- [5] R. Bayir, A. Albayrak, Intelligent control system of intra-frame beehive heater, *Int. J. of Computing Academic Research*, 5 4 (2016) 220-232.
- [6] S.V. Oskin, N.I. Bogatyrev, A.A. Kudryavtseva, Automatic temperature control system for a bee hive, In: A. Radionov, A. Karandaev (Eds.), *Advances in Automation, RusAutoCon 2019*, volume 641 of *Lecture Notes in Electrical Engineering*, Springer, Cham, 2020, pp 827-837. doi:10.1007/978-3-030-39225-390.
- [7] J. Kite-Powell, Here is a fully autonomous AI-powered beehive that could save bee colonies, *Forbes*, 2021. URL: <https://www.forbes.com/sites/jenniferhicks/2021/07/28/here-is-a-fully-autonomous-ai-powered-beehive-that-could-save-bee-colonies/>
- [8] Beewise, Earth's first robotic beehive is here, 2023. URL: <https://www.beewise.ag/>
- [9] N. Huu Du, N. Doan Dong, V. Thi Luu, N. Van Hoang, P. Hong Thai, P. Thanh Ngoc, N. Viet Long, P. Thi Thu Hong, Audio beehive monitoring based on IoT-AI techniques: A survey and perspective, *Vietnam J. of Agricultural Sciences*, 3 1 (2020) 530-540. doi:10.31817/vjas.2020.3.1.06.
- [10] S. Cecchi, A. Terenzi, S. Orcioni, S. Spinsante, V. Mariani Primiani, F. Moglie, S. Ruschioni, C. Mattei, P. Riolo, N. Isidoro, Multi-sensor platform for real time measurements of honey bee hive parameters, in: *Conf. Ser.: Earth Environ. Sci.*, 275, 012016, Ancona, Italy, 2018. doi:10.1088/1755-1315/275/1/012016
- [11] Electromania, Programming ESP8266 ESP-12E NodeMCU Using Arduino IDE, Autodesk, 2017. URL: <https://www.instructables.com/Programming-ESP8266-ESP-12E-NodeMCU-Using-Arduino-/>
- [12] L. Beaubien, C. Conrad, J. Music, S. Toze, Evaluating simplified web interfaces of risk models for clinical use: Pilot survey study, *JMIR Form Res*, e22110, 5.7 (2021).
- [13] M. Abdollahi, P. Giovenazzo, T.H. Falk, Automated beehive acoustics monitoring: A comprehensive review of the literature and recommendations for future work, *Appl. Sci.*, 3920 12 (2022). doi:10.3390/app12083920
- [14] S. Cecchi, S. Spinsante, A. Terenzi, S. Orcioni, A smart sensor-based measurement system for advanced bee hive monitoring, *J. Sensors*, 20 (2020) 2726. doi:10.3390/s20092726
- [15] T. Kimura, M. Ohashi, K. Crailsheim, T. Schmickl, R. Okada, G. Radspieler, H. Ikeno, Development of a new method to track multiple honey bees with complex behaviors on a flat laboratory arena, *J. PLOS ONE* 9 1 (2014). doi:10.1371/journal.pone.0084656